

Matched N-Channel JFET Pairs

Product Summary

Part Number	$V_{GS(off)}$ (V)	$V_{(BR)GSS}$ Min (V)	g_{fs} Min (mS)	I_G Typ (pA)	$ V_{GS1} - V_{GS2} $ Typ (mV)
U430	-1 to -4	-25	10	-15	25
U431	-2 to -6	-25	10	-15	25

Features

- Two-Chip Design
- High Slew Rate
- Low Offset/Drift Voltage
- Low Gate Leakage: 15 pA
- Low Noise
- High CMRR: 75 dB

Benefits

- Tight Differential Match vs. Current
- Improved Op Amp Speed, Settling Time Accuracy
- Minimum Input Error/Trimming Requirement
- Insignificant Signal Loss/Error Voltage
- High System Sensitivity
- Minimum Error with Large Input Signals

Applications

- Wideband Differential Amps
- High-Speed, Temp-Compensated, Single-Ended Input Amps
- High-Speed Comparators
- Impedance Converters

Description

The U430/431 are matched JFET pairs assembled in a TO-78 package. These devices offer good power gain even at frequencies beyond 250 MHz.

The TO-78 package is available with full military processing (see Military Information).

For similar products, see the low-noise U/SST401 series, the high-gain 2N5911/5912, and the low-leakage U421/423 data sheets.

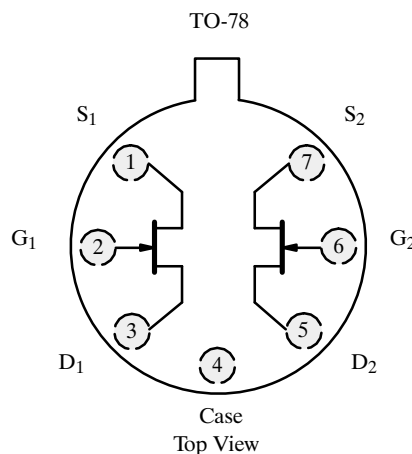

Absolute Maximum Ratings

Gate-Drain, Gate-Source Voltage -25 V
 Gate Current 10 mA
 Lead Temperature ($1/16$ " from case for 10 sec.) 300 °C
 Storage Temperature -65 to 200 °C
 Operating Junction Temperature -55 to 150 °C

Power Dissipation: Per Side^a 300 mW
 Total^b 500 mW

- Notes
- Derate 2.4 mW/°C above 25 °C
 - Derate 4 mW/°C above 25 °C

Specifications^a

Parameter	Symbol	Test Conditions	Typ ^b	Limits				Unit
				U430		U431		
				Min	Max	Min	Max	
Static								
Gate-Source Breakdown Voltage	$V_{(BR)GSS}$	$I_G = -1 \mu A, V_{DS} = 0 V$	-35	-25		-25		V
Gate-Source Cutoff Voltage	$V_{GS(off)}$	$V_{DS} = 10 V, I_D = 1 nA$		-1	-4	-2	-6	
Saturation Drain Current ^c	I_{DSS}	$V_{DS} = 10 V, V_{GS} = 0 V$		12	30	24	60	mA
Gate Reverse Current	I_{GSS}	$V_{GS} = -15 V, V_{DS} = 0 V$ $T_A = 150^\circ C$	-5		-150		-150	pA
			-10		-150		-150	nA
Gate Operating Current	I_G	$V_{DG} = 10 V, I_D = 5 mA$ $T_A = 150^\circ C$	-15					pA
			-10					nA
Gate-Source Forward Voltage	$V_{GS(F)}$	$I_G = 10 mA, V_{DS} = 0 V$	0.8		1		1	V
Dynamic								
Common-Source Forward Transconductance ^c	g_{fs}	$V_{DS} = 10 V, I_D = 10 mA, f = 1 kHz$	15	10		10		mS
Common-Source Output Conductance ^c	g_{os}		100		250		250	μS
Common-Source Input Capacitance	C_{iss}	$V_{GS} = -10 V, V_{DS} = 0 V, f = 1 MHz$	4.5		5		5	pF
Common-Source Reverse Transfer Capacitance	C_{rss}		2		2.5		2.5	
Equivalent Input Noise Voltage	\bar{e}_n	$V_{DS} = 10 V, I_D = 10 mA, f = 100 Hz$	6					nV/\sqrt{Hz}
High Frequency								
Common-Source Forward Transconductance	g_{fs}	$V_{DS} = 10 V, I_D = 10 mA$ $f = 100 MHz$	14					mS
Common-Source Output Conductance	g_{os}		0.13					
Power-Match Source Admittance	g_{sig}		12					
Matching								
Differential Gate-Source Voltage	$ V_{GS1} - V_{GS2} $	$V_{DG} = 10 V, I_D = 10 mA$	25					mV
Saturation Drain Current Ratio ^d	$\frac{I_{DSS1}}{I_{DSS2}}$	$V_{DS} = 10 V, V_{GS} = 0 V$	0.95	0.9	1	0.9	1	
Transconductance Ratio ^d	$\frac{g_{fs1}}{g_{fs2}}$	$V_{DS} = 10 V, I_D = 10 mA, f = 1 kHz$	0.95	0.9	1	0.9	1	
Gate-Source Cutoff Voltage Ratio ^d	$\frac{V_{GS(off)1}}{V_{GS(off)2}}$	$V_{DS} = 10 V, I_D = 1 nA$	0.95	0.9	1	0.9	1	
Differential Gate Current	$ I_{G1} - I_{G2} $	$V_{DG} = 10 V, I_D = 5 mA$	-2					pA
Common Mode Rejection Ratio	CMRR	$V_{DG} = 5 to 10 V, I_D = 10 mA$	75					dB

Notes

- $T_A = 25^\circ C$ unless otherwise noted.
- Typical values are for DESIGN AID ONLY, not guaranteed nor subject to production testing.
- Pulse test: $PW \leq 300 \mu s$ duty cycle $\leq 3\%$.
- Assumes smaller value in the numerator.

NZBD

Typical Characteristics

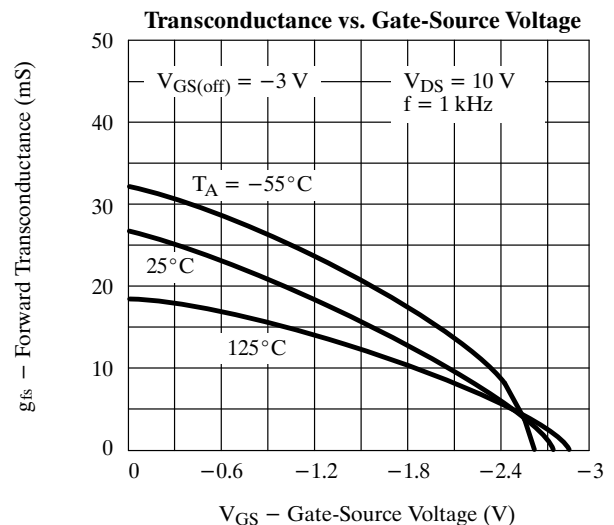
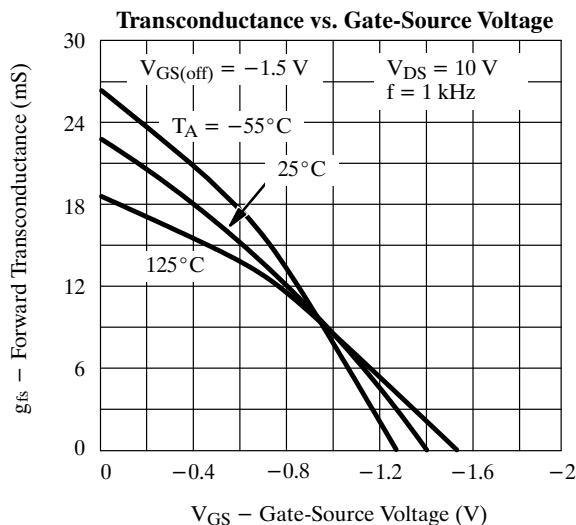
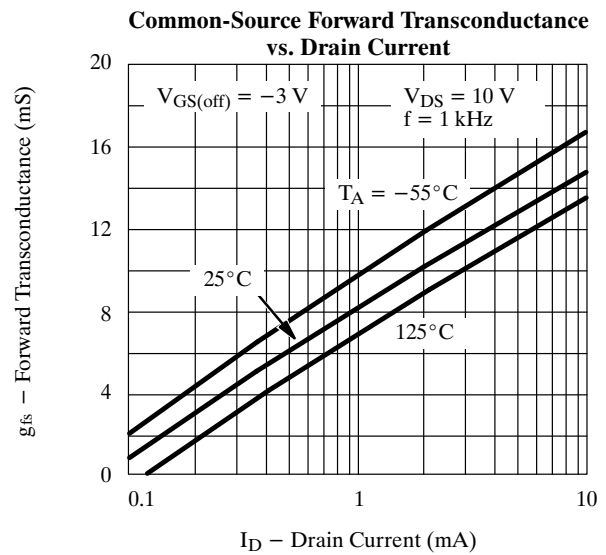
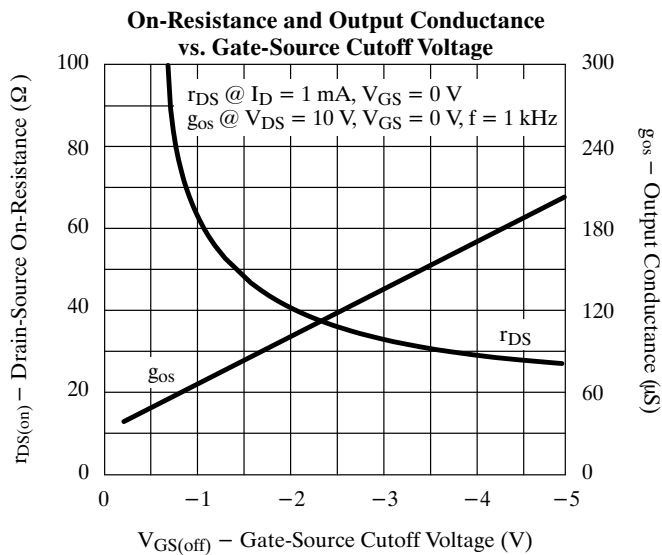
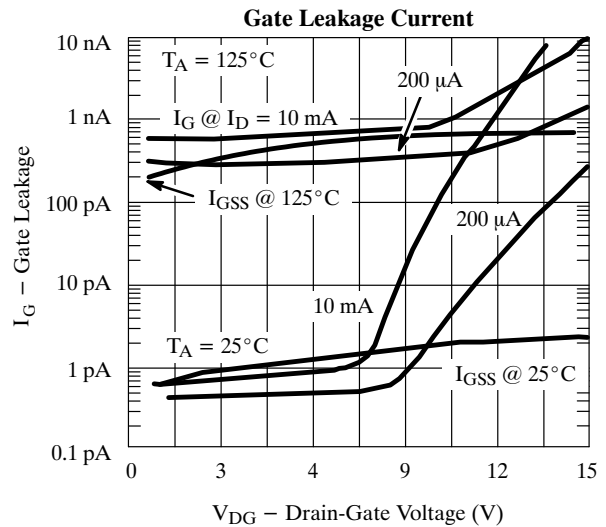
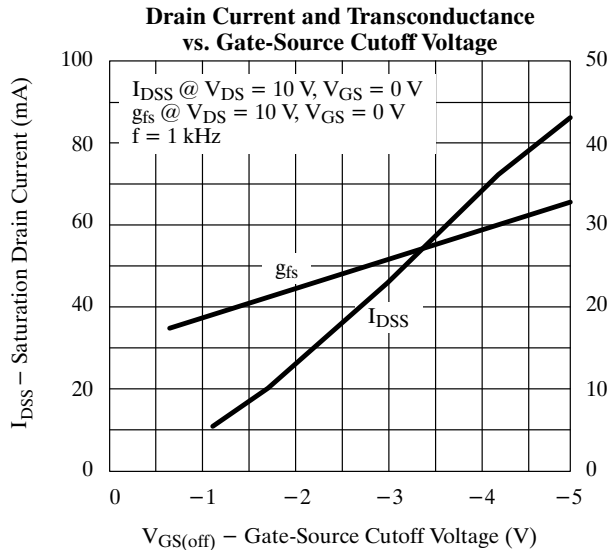

Typical Characteristics (Cont'd)

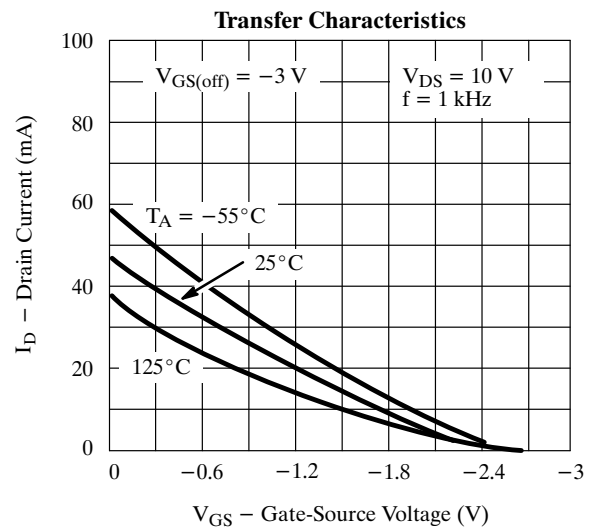
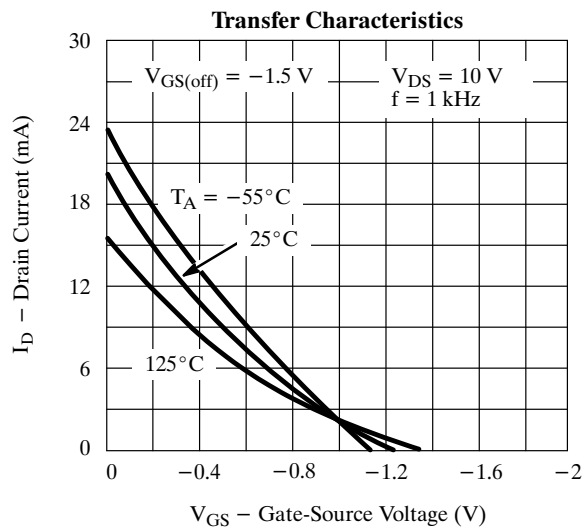
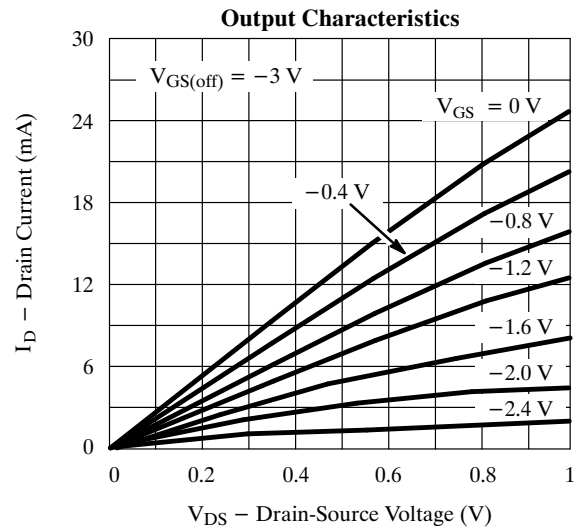
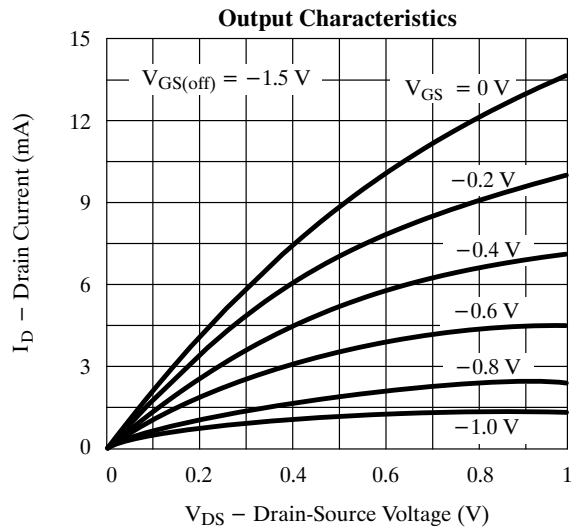
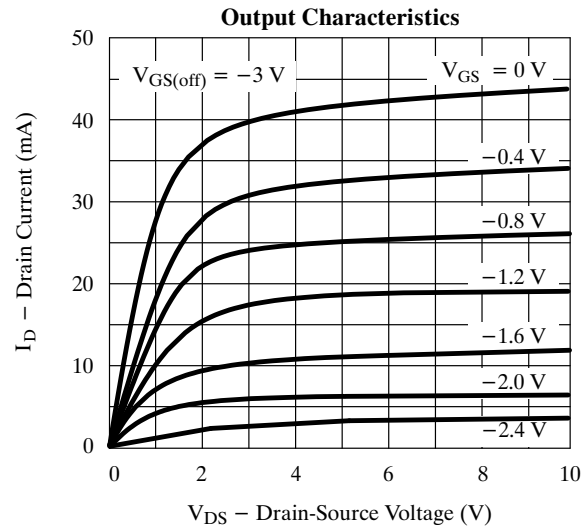
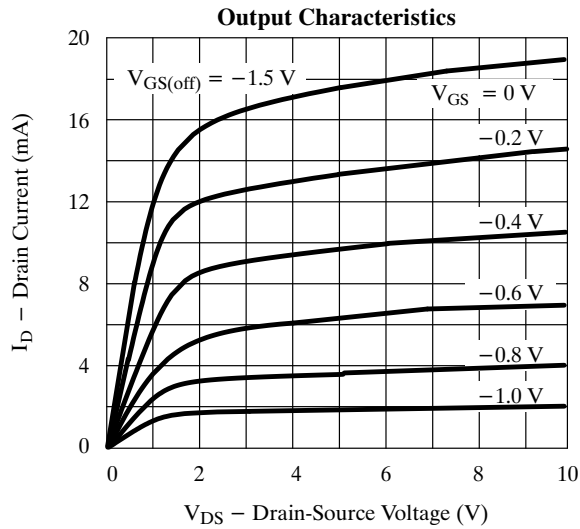

Typical Characteristics (Cont'd)

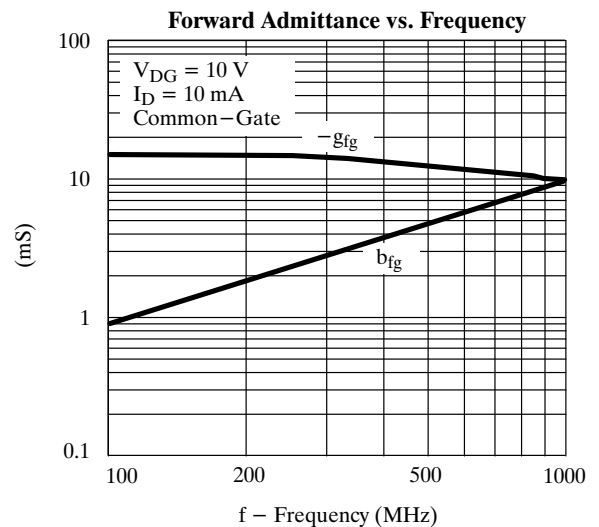
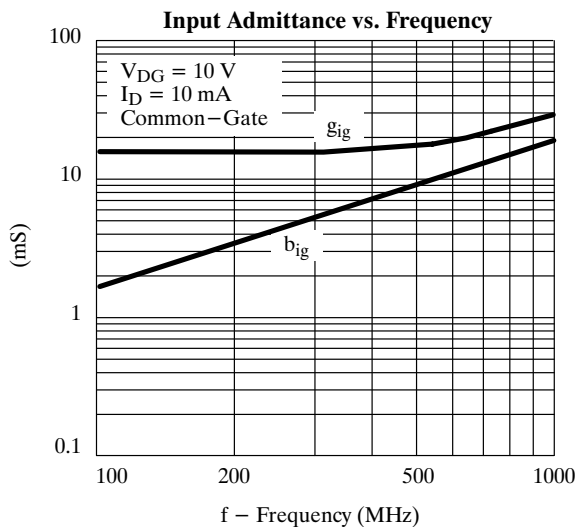
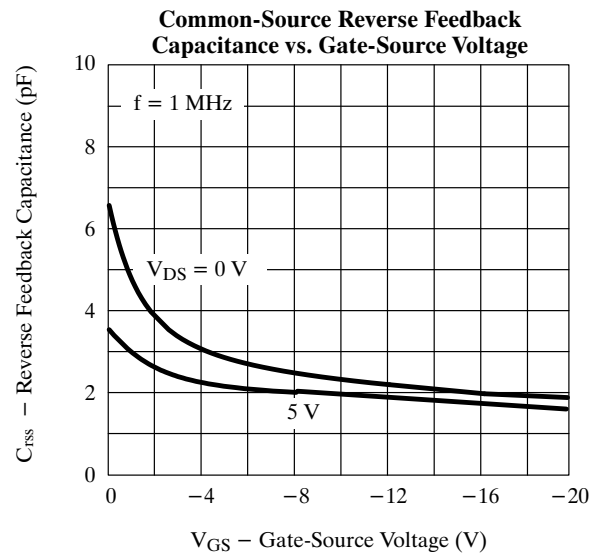
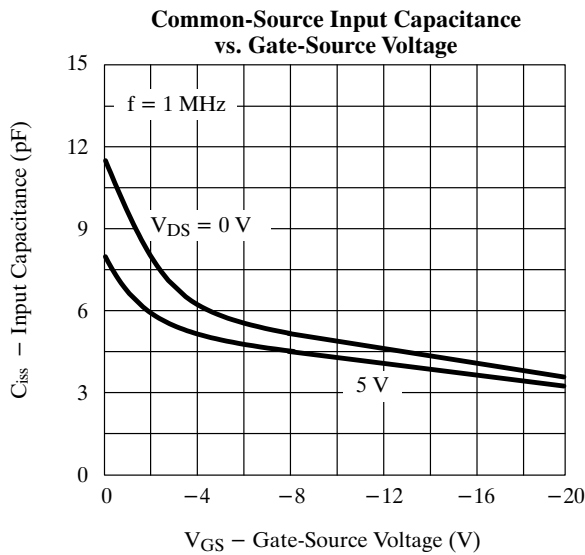
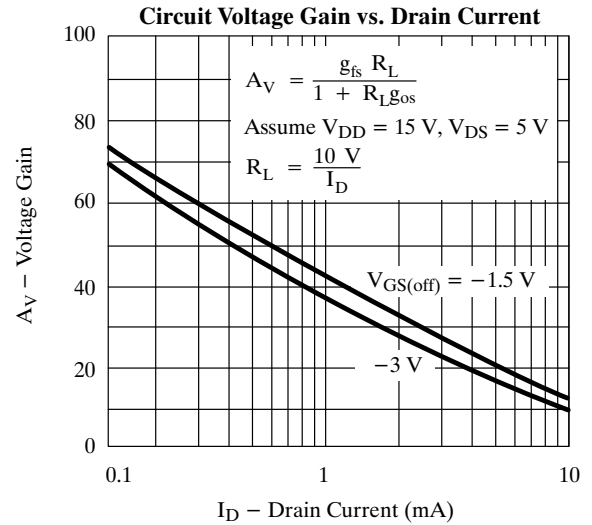
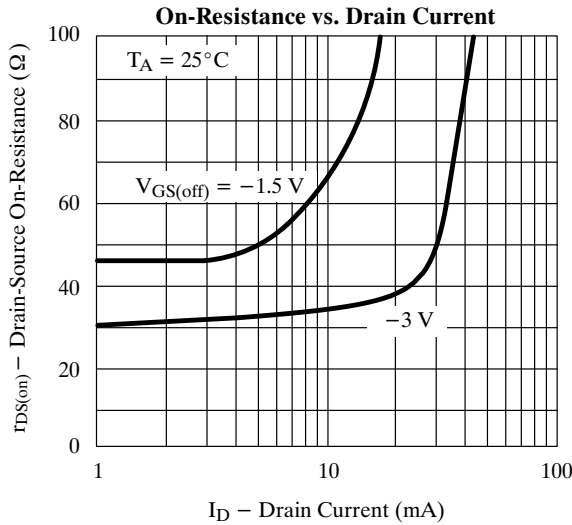

Typical Characteristics (Cont'd)

